

# STANDARD TIMBER FINISHED SIZES AND PROFILES

# 2005



## Introduction

The principle objective of this document is to describe to the building industry, specifiers, renovators and end-users standard timber sizes and moulding profiles that are commonly available on the East Coast of Australia. The document can be used by producers, suppliers and importers to encourage uniformity in supply to the industry.

For information on availability please visit [www.tabma.com.au](http://www.tabma.com.au) to find your closest TABMA member.

## Contents

	Page
Industry Standard Timber Sizes .....	2-4
Engineered Wood Products .....	4
Architraves and Skirting .....	5
Architraves and Skirting – Queensland and Northern NSW .....	6
Sundry Mouldings .....	7-8
Protective Coated – Finger Jointed Pine .....	9-10
Sundry Treated Pine H3 Products Exterior Use .....	11
External Wall Cladding .....	12-13
Flooring and Decking .....	14
Internal Lining .....	15
Internal Staircase Components .....	16
Door Jambs, Door and Casement Framing, Casement Sills .....	17
Detail of Box Frame Material 38mm Sash Stock .....	18
Detail of Box Frame Material 44mm Sash Stock .....	19
Window Framing .....	20
Treated Timber Hazard Level Guide .....	21
Mouldings – Full size and to Scale .....	22

**DISCLAIMER:** Although TABMA has taken due care in preparing the information in this document, it is intended merely as a guide to assist industry participants. In no way is TABMA warranting the accuracy or completeness of the information. Nor is TABMA making any representation on the suitability, safety, quality or availability of any product referred to in this document. In making any decisions about products, based on the information in this document, you should make your own independent enquiries in relation to the suitability, safety, quality and/or availability of the products for your intended use.

## Acknowledgements

This publication was formulated after lengthy consultation with industry together with input from several industry associations and many producers, suppliers, wholesalers and merchants. Forest and Wood Products Research and Development Corporation are the major sponsors of this publication.

Acknowledgement is also given to both the NZ Pine Manufacturers Association and the NSW Timber Importers Association for their invaluable in-kind contribution.

Published by the Timber & Building Materials Association (NSW) Ltd. ABN 12 000 045 956  
13-29 Nichols Street, Surry Hills NSW 2010 Australia. PO Box 107, Surry Hills NSW 2010 Australia  
Telephone (02) 9360 3088 Fax (02) 9360 3464 [info@tabma.com.au](mailto:info@tabma.com.au) [www.tabma.com.au](http://www.tabma.com.au)

# SECTION A

## Appearance Grade Timber Dressed

### Recommended Finished Timber Sizes

**Table 1**

Species include  
Finger Jointed  
Pine (unprimed,  
treated and  
primed), Pacific  
Maple, Oregon,  
Victorian Ash,  
Tasmanian Oak,  
Hardwood, WRC  
and other species  
Kiln Dried

Width	Thickness							
	12	18	30	42	66	90	116	138
12	12	18	30	42	66	90		
18	12	18	30	42	66	90	116	138
30	12	18	30	42	66	90	116	138
42	12	18	30	42	66	90	116	138
66	12	18	30	42	66	90	116	138
90	12	18	30	42	66	90	116	
92	12	18	30	42				
110	12	18			66	90		
116	12	18	30	42	66	90	116	138
138	12	18	30	42	66	90		138
165		18						
185		18	30	42	66	90		
230		18	30	42	66	90		
280		18	30	42	66	90		

- Notes: 1 All dressed timber will be square edged unless noted below.  
 2 92mm Queensland only. FJ.  
 3 Treated Pine DAR primed all pencil round 2.0mm radius  
 4 Pacific Maple, Oregon, WRC, Tasmanian Oak, etc, will be 235mm and 285mm..  
 5 Some species may have up to 1.0mm variation.  
 6 Finger Jointed Pine will be 11.0mm.  
 7 Special sizes can be produced subject to "Special Order".

**Table 2**

Radiata Pine  
Dressed  
Appearance Grades  
Kiln Dried

Width	Thickness						
	12	19	35	42	45	70	90
12	12	19		42		70	90
19	12	19	35	42		70	90
35				42			
42	12	19	35	42			
45			35			70	90
70	12	19	35		45	70	90
90	12	19	35		45	70	90
120		19	35		45		
140	12	19	35		45		
170		19					
190		19	35		45		
240		19	35		45		
290		19	35		45		

**Recommended Finished Timber Sizes**

Tables 1 and 2 are finished sizes relevant to the Australian building industry, although comprehensive this does not describe exact market availability

**Table 1**  
**Pine and**  
**Hardwood KD**  
Solid, Gauged

Width	Thickness			
	35	45	70	90
35		45	70	90
45			70	90
70	35	45	70	90
90	35	45	70	90
120	35	45		
140	35	45	70	
170	35	45		
190	35	45	70	
220	35	45		
240	35	45	70	
270	35	45		
290	35	45	70	

Notes: 1 Incorporates Radiata and KD Hardwood in all relevant F & MGP strength ratings, treated or untreated.

**Table 2**  
**Treated**  
**Pine Primed**  
H3 Finger Jointed &  
Laminated includes  
F7, GL8 & GL10  
Kiln dried

Width	Thickness		
	30	42	65
66	30	42	
90	30	42	
138	30	42	
140			65
180			65
185		42	
230		42	
240			65
280		42	65

**F8 Treated Primed Pine Posts**

	<b>88</b>	<b>112</b>	<b>135</b>	<b>185</b>
88	88			
112		112		
135			135	
185				185

Notes: 1 Treated Pine Primed Posts will have 2.0 mm radius pencil round.  
2 Some sizes and grades are subject to availability at the time of order.  
3 The above table and notes are based on the common sizes and grades available.  
4 65mm only available in GL8 and GL10.  
5 The above are suitable for above ground only.

## Sawn Timber Sizes

### Recommended Nominal Timber Sizes (unseasoned)

Width	Thickness									
	25	38	50	75	100	125	150	200	250	300
50	25	38	50							
75	25	38	50	75						
100	25	38	50	75	100					
125	25	38	50	75	100	125				
150	25	38	50	75	100	125	150			
175	25	38	50	75	100	125	150			
200	25	38	50	75	100	125	150	200		
225	25	38	50	75	100	125	150	200		
250	25	38	50	75	100	125	150	200	250	
300	25	38	50	75	100	125	150	200	250	300

- Notes: 1 Refer to the relevant standards for each species.  
 2 The above are common sizes; other sizes are available on request.  
 3 Fine sawn Oregon as per the dressed sizes.

## Engineered Wood Products

### Laminated Veneer Lumber (LVL)

Sizes (mm)	36	45	63	75
95	36	45	63	–
130	36	45	63	–
150	36	45	63	75
170	36	45	63	–
200	36	45	63	–
240	36	45	63	–
300	–	45	63	75
360	–	45	63	–
400	–	45	63	75
450	–	–	63	75
525	–	–	–	–

- Notes: • Lengths to 14.4m in 300 increments.  
 • Treated or untreated.  
 • Refer to suppliers' span tables.

### I-Joists – Sizes by Producer

Producer	Size 1	Size 2
Producer 1	200 x 44	240 x 51
	300 x 51	360 x 58
	400 x 58	
Producer 2	200 x 70	241 x 70
	302 x 70	356 x 70
	406 x 70	200 x 90
	241 x 90	302 x 90
	356 x 90	406 x 90
Producer 3	200 x 68	245 x 68
	300 x 68	360 x 68
	200 x 88	245 x 88
	300 x 88	360 x 88
Producer 4	200 x 47	240 x 47
	246 x 47	246 x 57
	300 x 63	360 x 63

## Bullnose AS1

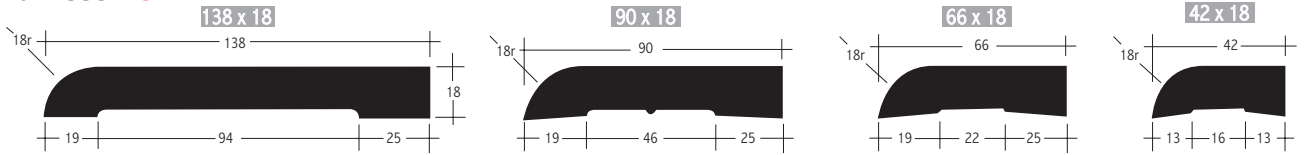

## Colonial\* AS2

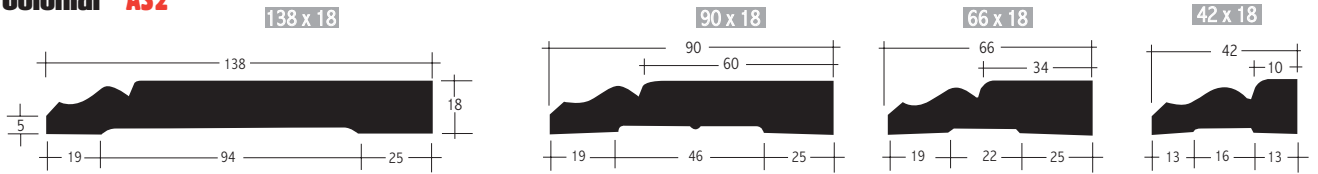

## Bevel AS3

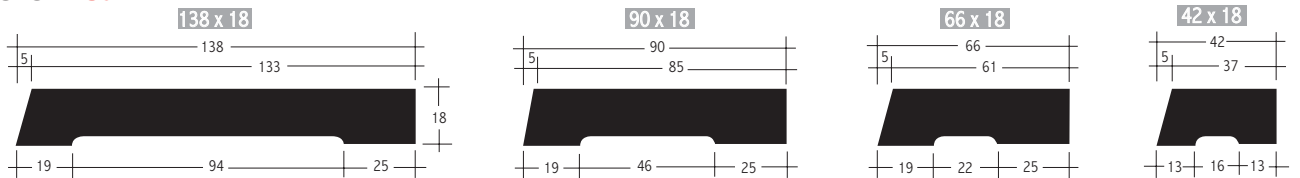

## Half Splayed Type A AS4

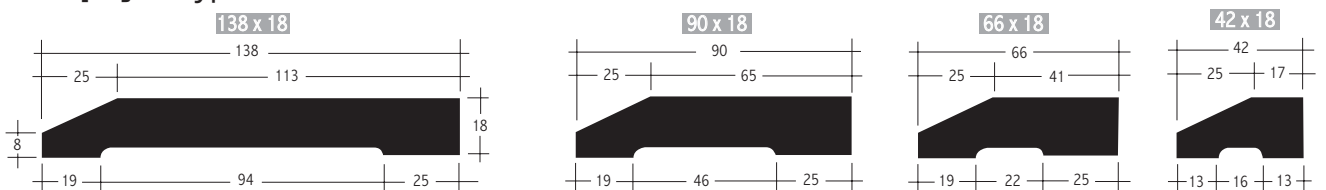

## Half Splayed Type B AS5

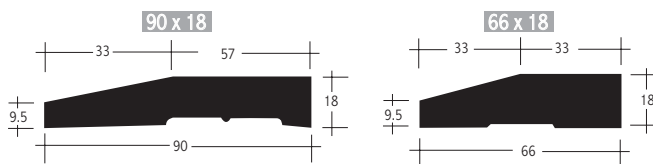

## Full Splayed AS6

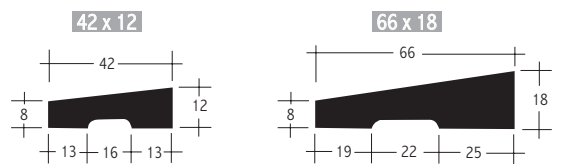

## Pencil Round AS7

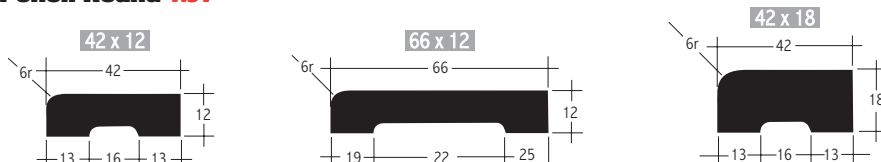

\*Refer to page 23 for full size profile of Colonial

# ARCHITRAVES AND SKIRTINGS

## Queensland and Northern NSW

### Splayed AS8

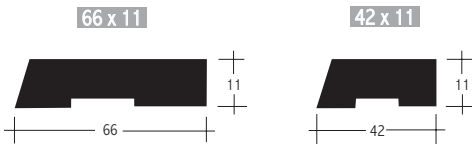

### Bullnose AS9

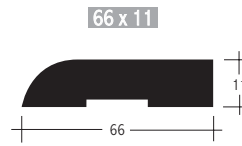

### Colonial 2 AS10

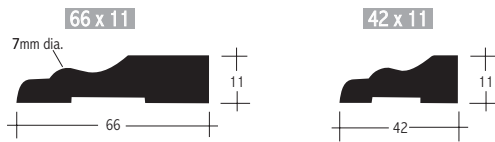

### Step AS12

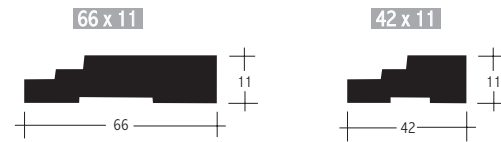

### Queensland Colonial AS13



### Classic AS14



### Pencil Round AS15



**Quad SM1**

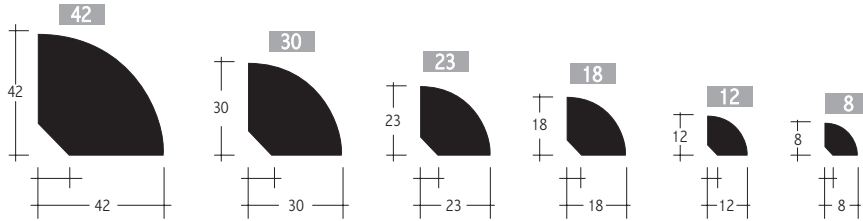

**Cover Strip SM6**

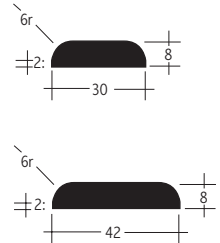

**Scotia SM2**

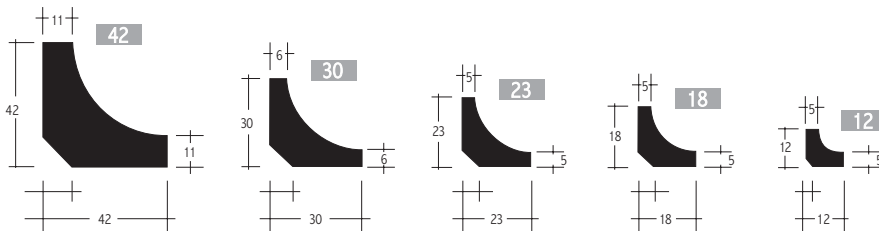

**Square Edged Cover Strip SM7**

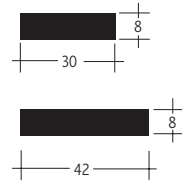

**Ovolo SM3**

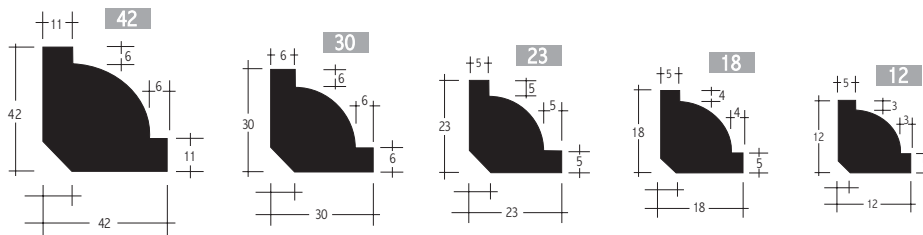

**Half Round SM8**

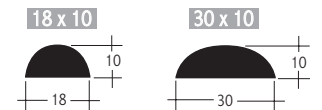

Note: 25% of width backed off

**38\*mm Nosing**

**Full SM4**

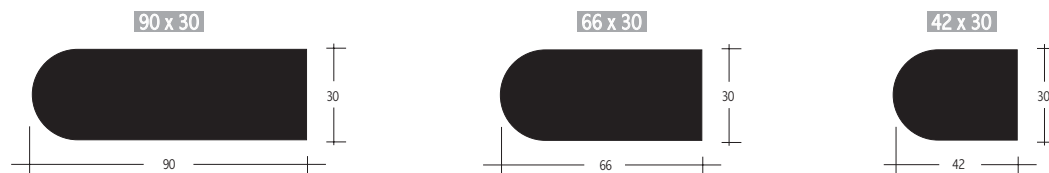

**Splayed SM5**

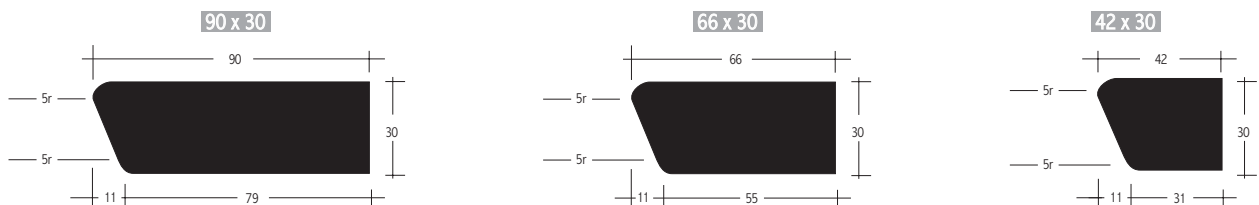



**Inlay SM9**

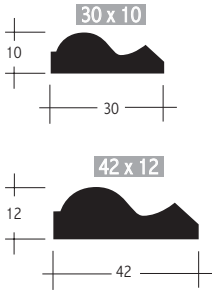

**Bolection SM10**

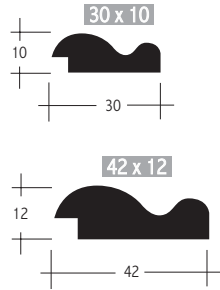

**Sash Stop Bead SM11**

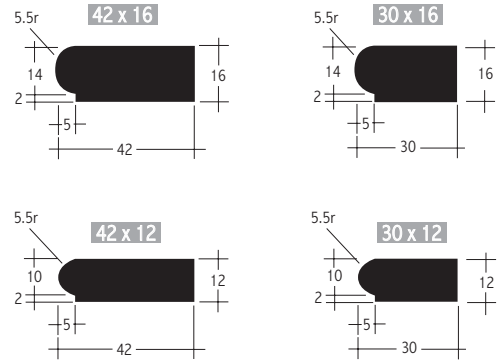

**Picture Rail SM12**

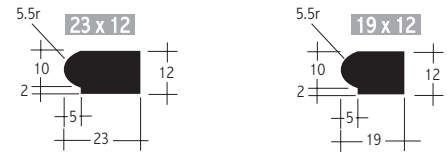
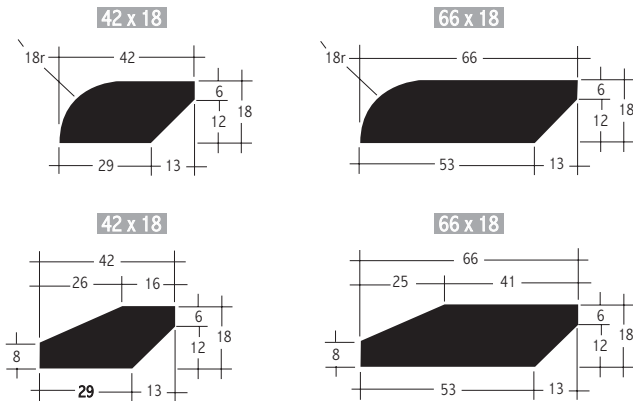

**Parting Bead SM13**

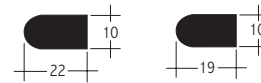

**Glazing Bead SM14**

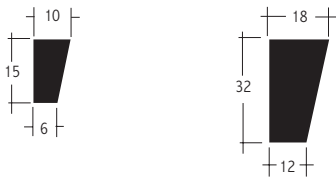

**Sash Bead SM15**

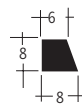

**Colonial GLZ Bar SM16**

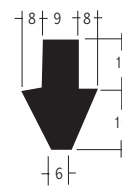

**Stormould SM17**



**External Corner SM18**

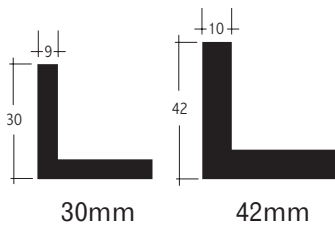

# PROTECTIVE COATED TREATED H3 FINGER JOINTED PINE EXTERIOR USE (above ground only)

## Handrails

**T1**

79 x 63

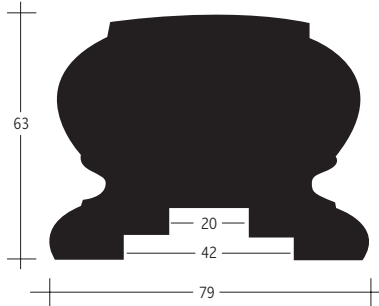

**T2**

88 x 42

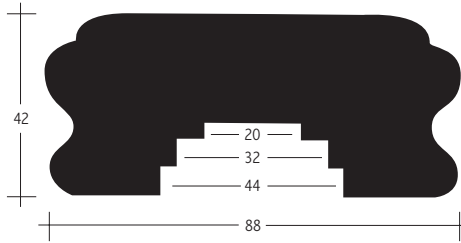

**T3**

66 x 42

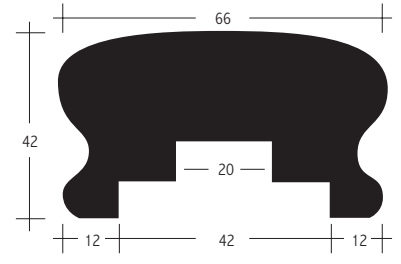

## Bottom Rails

**T4**

80 x 30

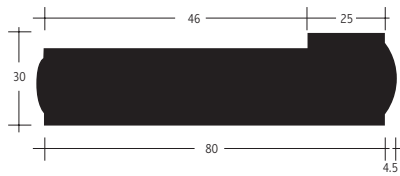

**T5**

86 x 42

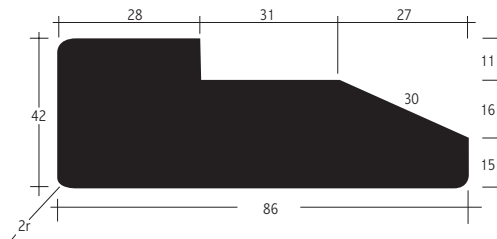

**T6**

66 x 30

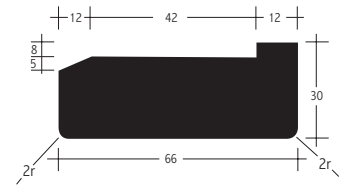

\*Refer to page 23 for full size profile

## 25 mm Fascia **T7**

180 x 25

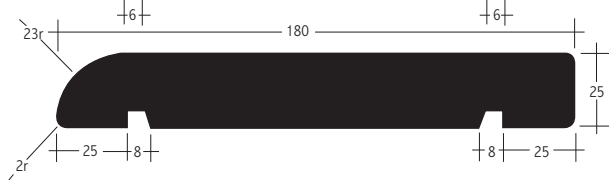

## 18 mm Fascia **T8**

180 x 18

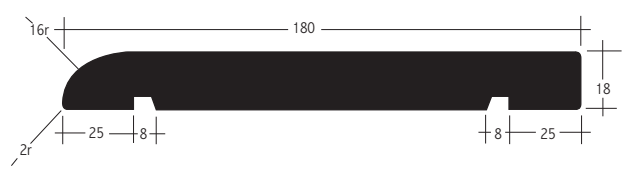

135 x 25

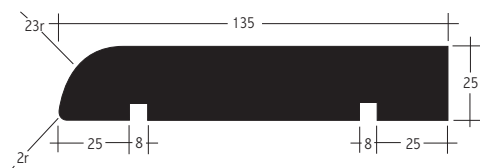

135 x 18

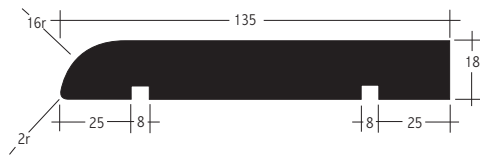

# PROTECTIVE COATED TREATED H3 FINGER JOINTED PINE EXTERIOR USE (above ground only)

## Posts FJ and laminated T9

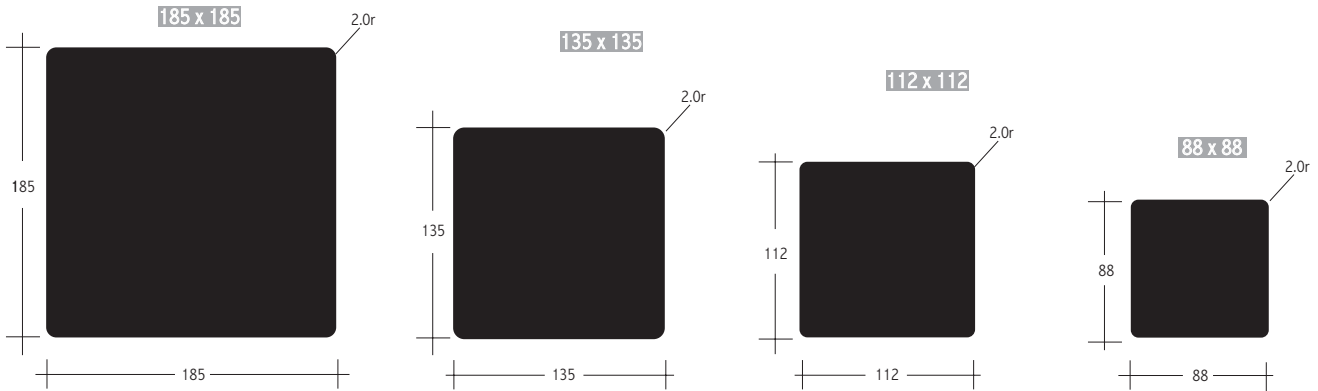

## Structural Beams T10

Laminated Beams

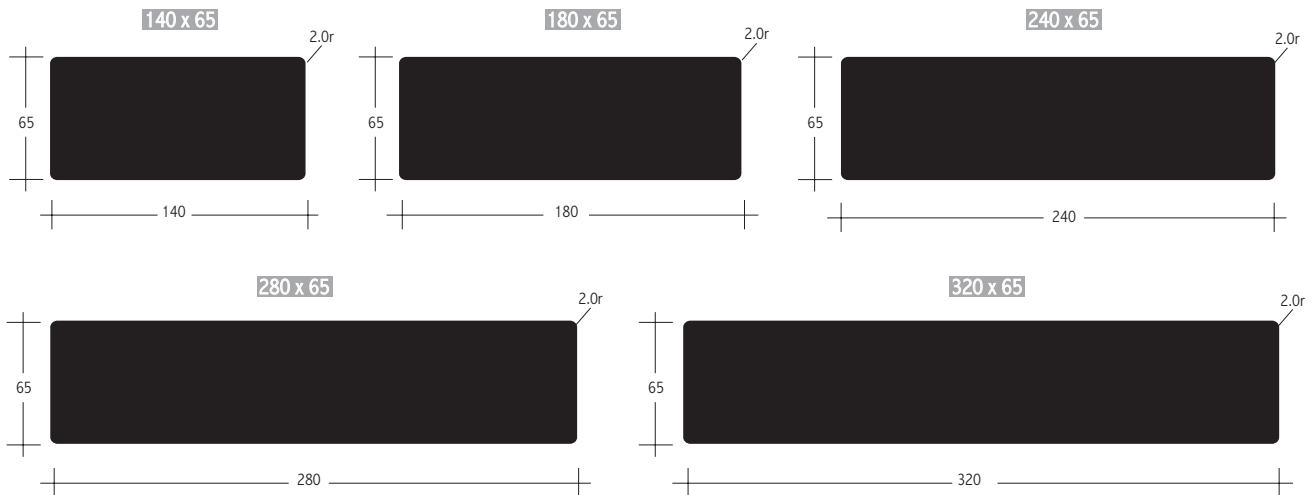

## Weather Boards T11

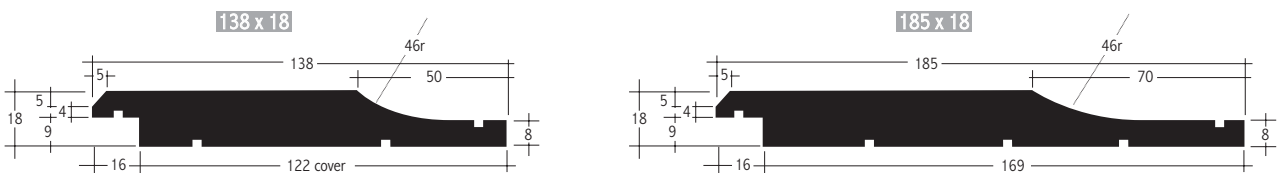

**Lattice surround T25**

To fit sawn lattice

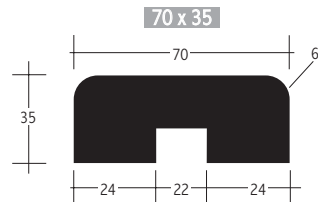
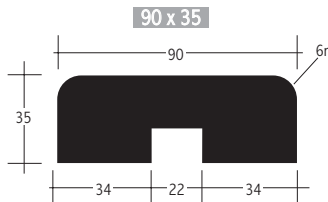

To fit dressed lattice

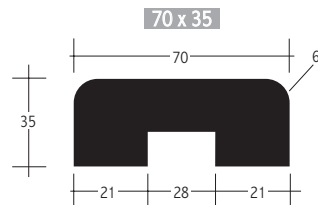
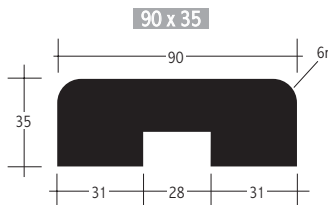

**Fence capping T30**

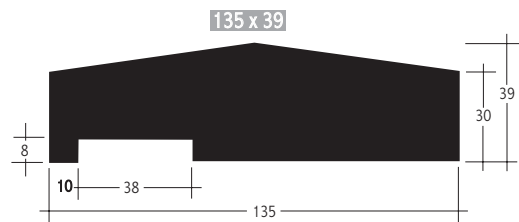
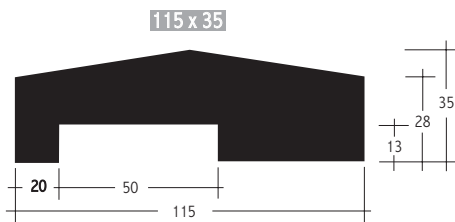

**Important Recommendations when using Treated Timber**

- 1 Use corrosion resistant fasteners, i.e. hot dipped galvanised or stainless steel bolts, plates, nails, etc.
- 2 End seal after cutting and seal all housed or checked joints prior to installing.
- 3 As a general rule use oil-based undercoats over primed treated timber.

## White Cypress Unseasoned

Round log cabin **EC1** ex 100 x 25

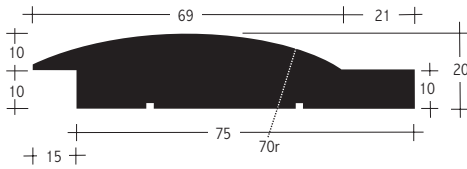

Round double log cabin **EC2** ex 150 x 25

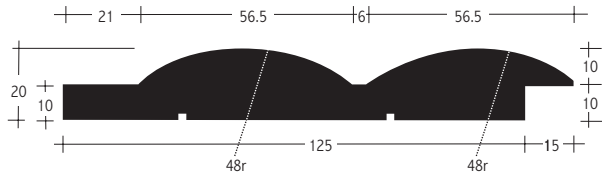

Flat log cabin **EC3** ex 100 x 25

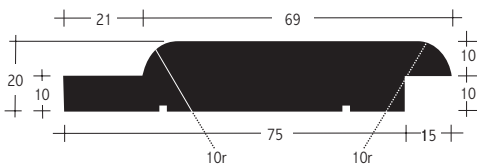

Flat double log cabin **EC4** ex 150 x 25

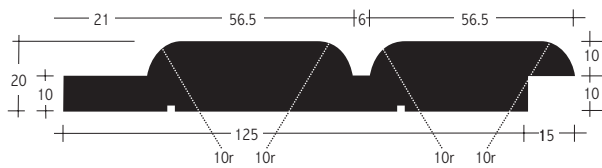

## Rusticated **EC5**

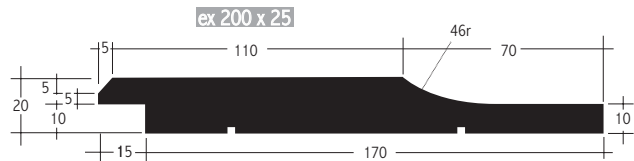
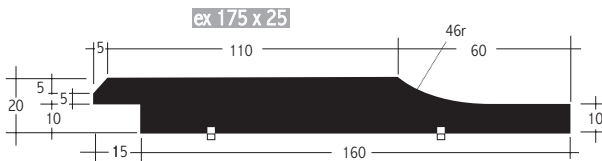
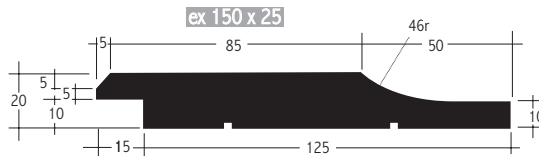
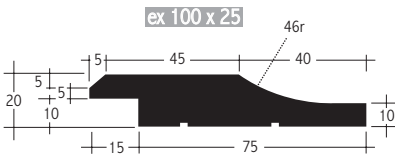

## Checked and nosed (tear drop) **EC6**

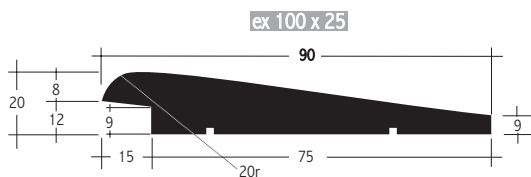

## Double checked and nosed (double tear drop) **EC7**

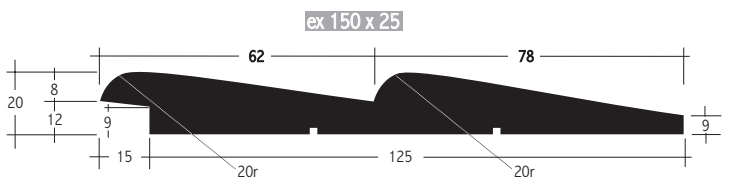

**Western Red Cedar**

Unseasoned select – Bevel sawn siding **EC8**

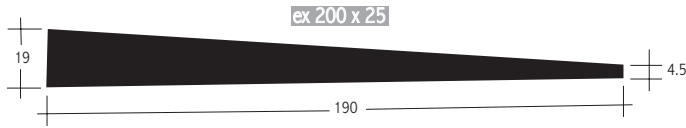

Seasoned clear grade

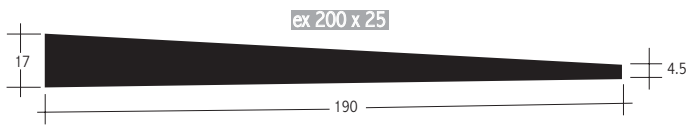

Note: Recommended cover 160

Tongued and Grooved **EC9**  
V Joint

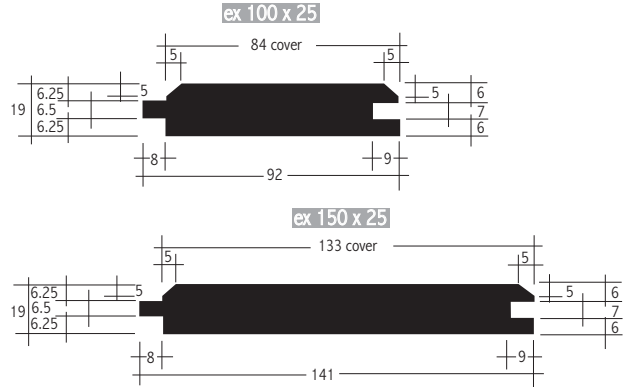

Shiplap **EC10**

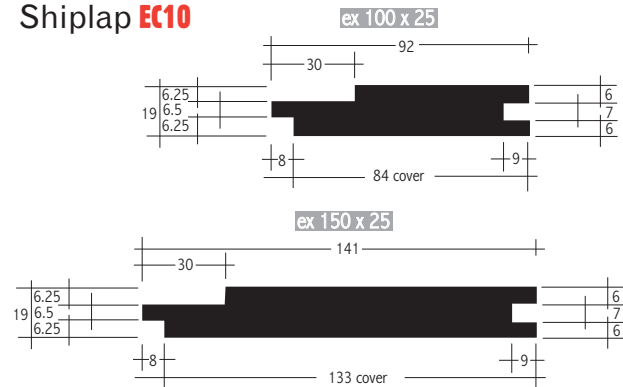

**Baltic Pine**

Checked and Chamfered **EC11**

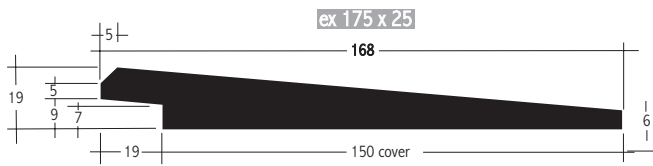

**Radiata Pine**

Treated Seasoned  
Shiplap Dressed face **EC12**

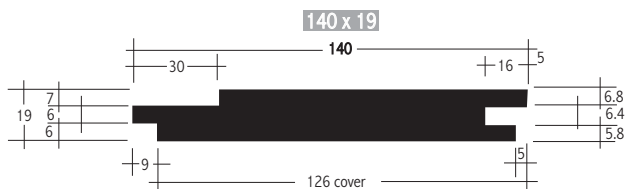

Rusticated Dressed Face **EC14**

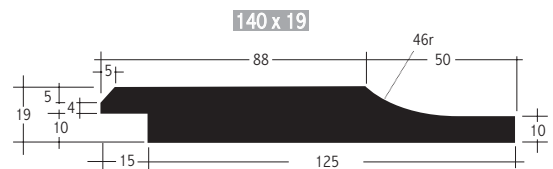

Shiplap Sawn Face **EC13**

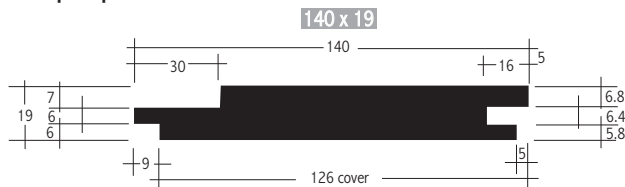

Treated CCA Kiln Dried Siding **EC15**  
Sawface

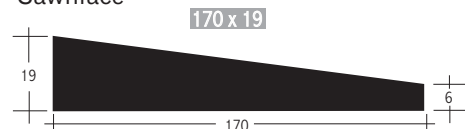

## Hardwood Structural Flooring

Secret nail **FD1**

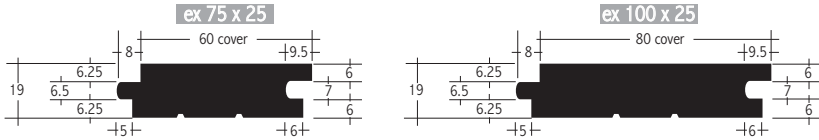

Top nail **FD2**

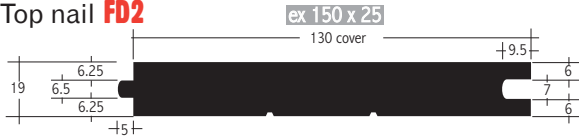

Secret nail **FD3**

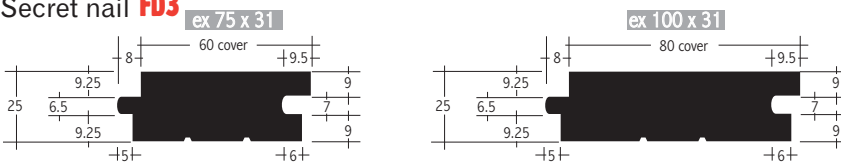

## White Cypress **FD5**

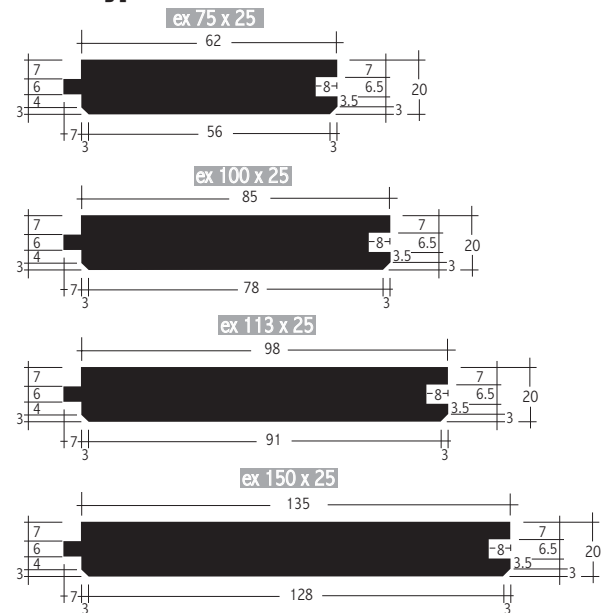

## Radiata Pine **FD6**

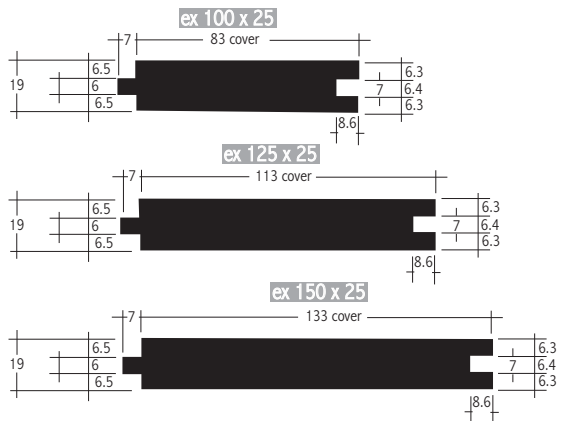

## Baltic **FD7**

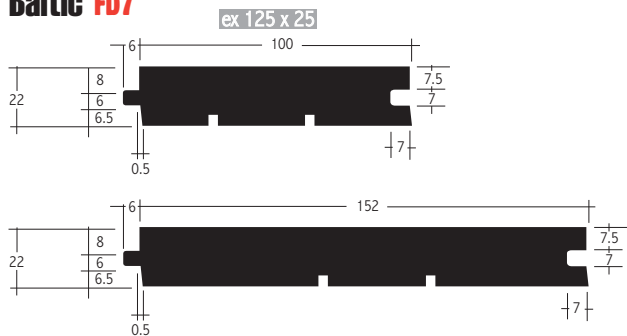

## Decking Seasoned (based on 450mm centre)

Hardwood Reversible **FD8**

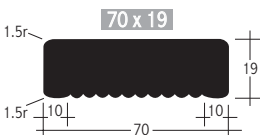

Pine Treated Reversible **FD9**

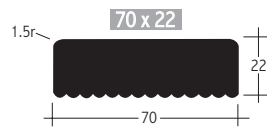

Hardwood Local **FD10**

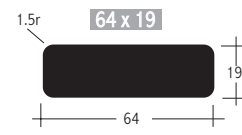

White Cypress **FD11**

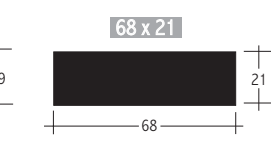
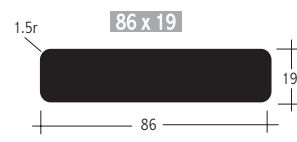
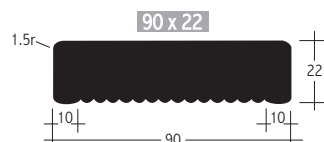
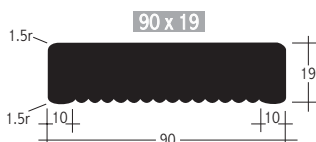
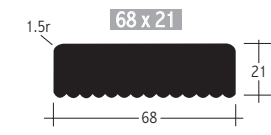

**Internal Panelling – Tongued and Grooved**

**Pine Seasoned**

**V Jointed and Centre V Groove L1**

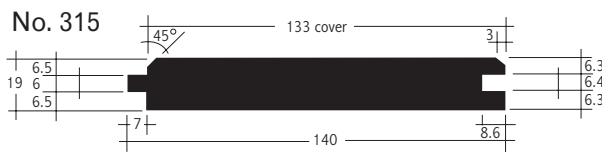
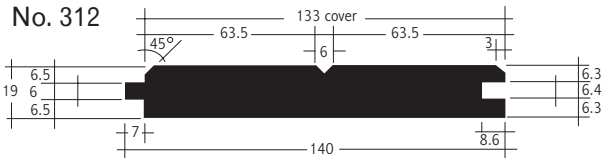

**Double V Jointed and Centre Groove L2**

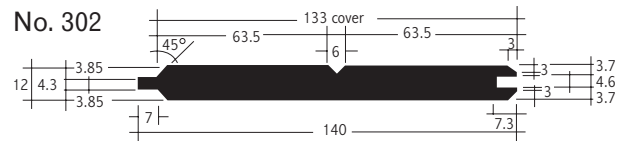
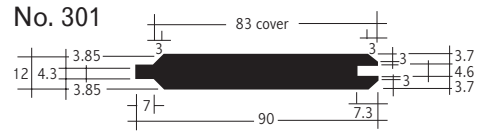

**V Jointed – Regency – Centre Groove and Shiplap L3**

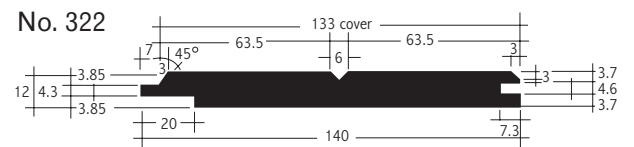
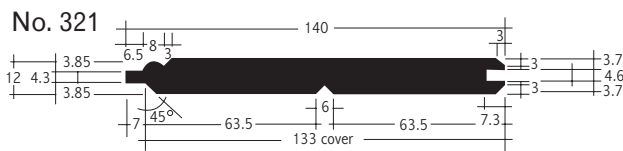

**Western Red Cedar Seasoned & Tasmanian Oak Seasoned**

**V Jointed L4**

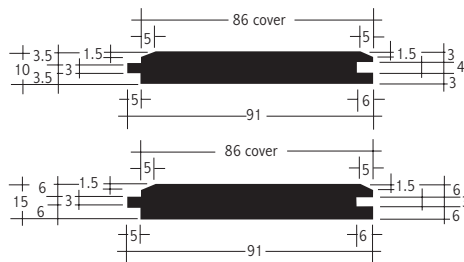

**Shiplap L5**

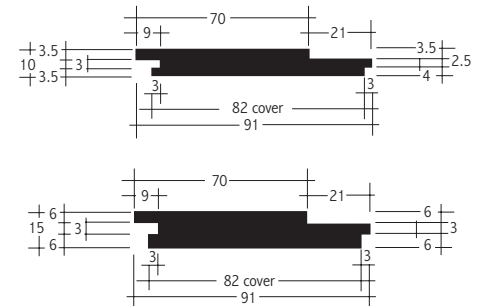

**Double V Jointed and Centre V Groove L6**

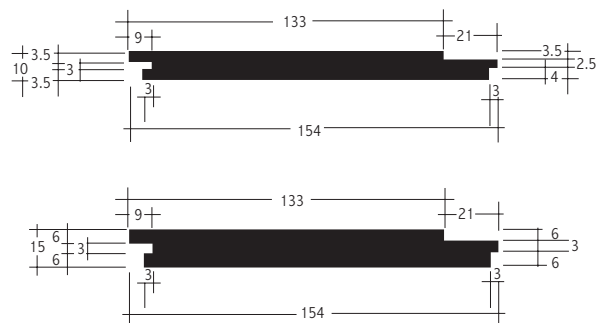
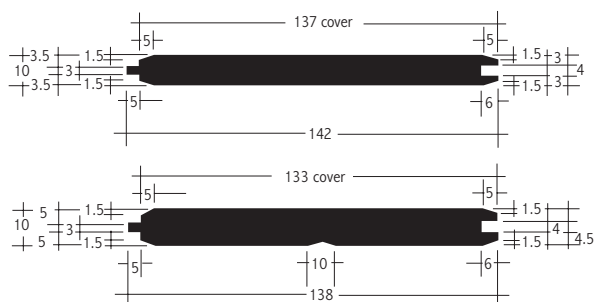

**Regency V Jointed L7**





## Handrails

**IS1** 66 x 41

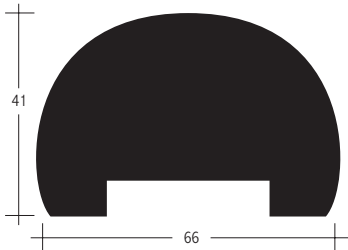

**IS2** 66 x 41

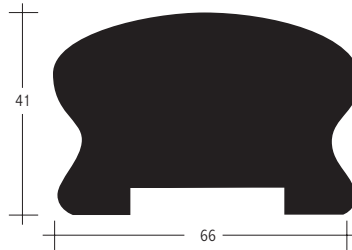

**IS3** 65 x 65

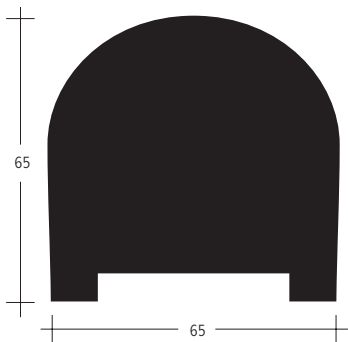

**IS4** 65 x 65

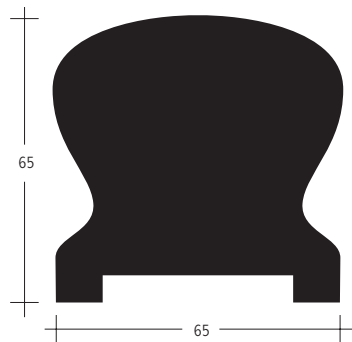

**IS5** 80 x 65

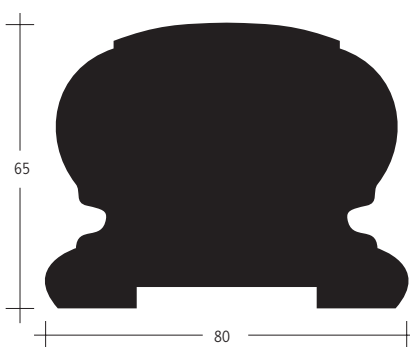

**IS6** 80 x 65

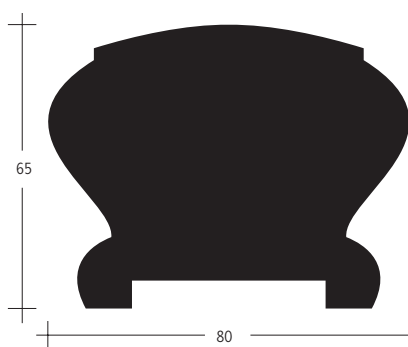

**IS7** 65 x 65

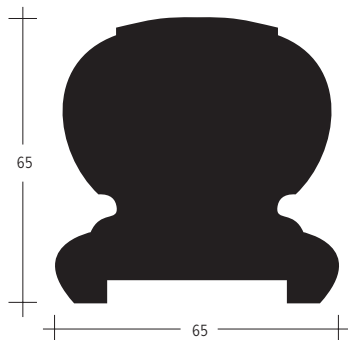

NB Inside grooving can vary between 12, 16, 38, 42, and 44mm width and 8mm depth.

## 75\*mm Door Framing & Jambs J1

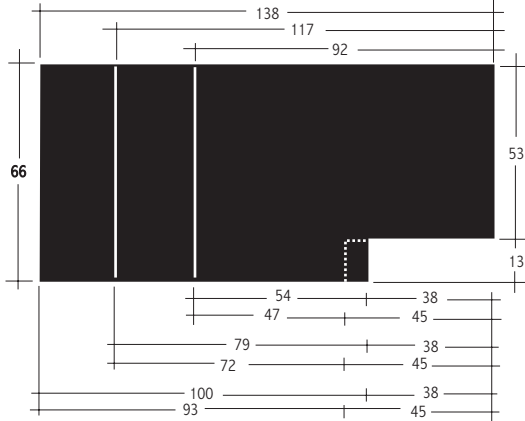

## 75\*mm Door Mullions J2

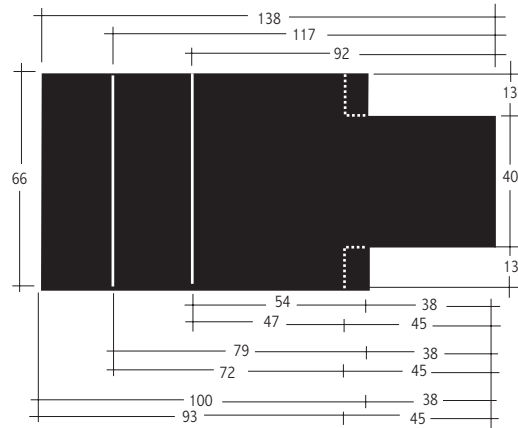

## 50\*mm Door Framing & Jambs J3

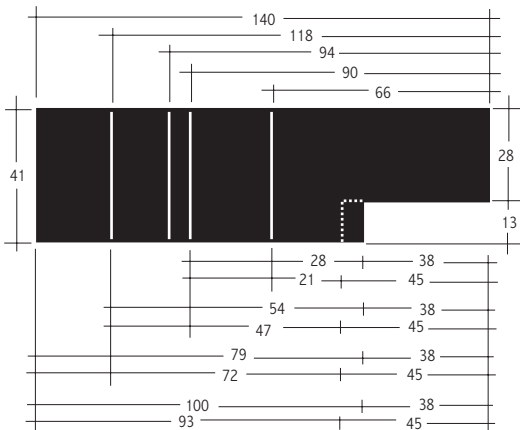

## Casement Sills J4

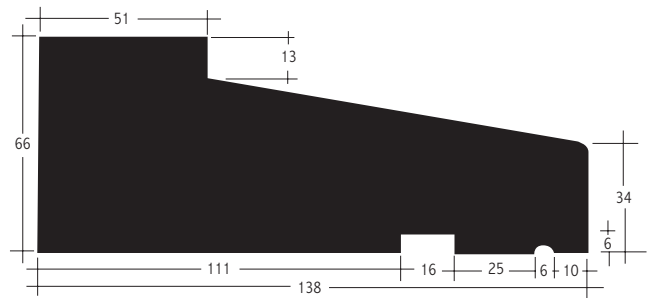

## 30\*mm Jamb Lining J5

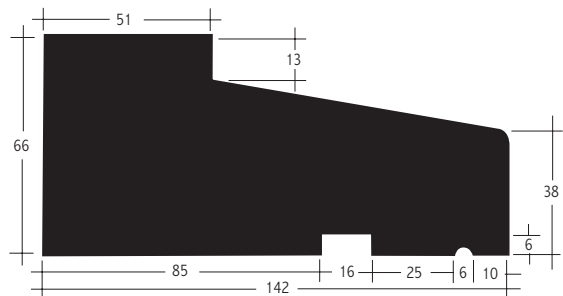
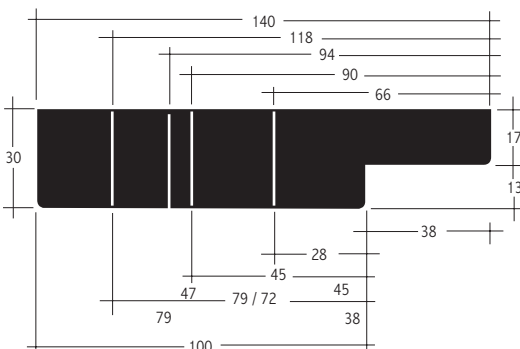

## 30mm Jambs FJ Pine only J6

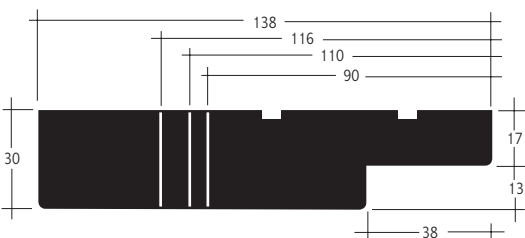

## 38\*mm Threshold J7

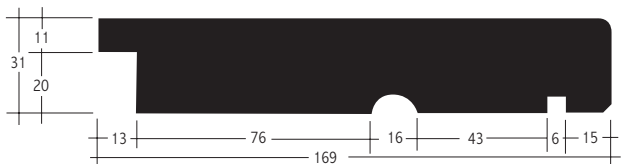

Note: refer to pages 17-18 for Box Frame Window Sill Profiles

# DETAIL OF BOX FRAME MATERIAL AND 38mm SASH STOCK

## Vertical Section through Sill Sashes and Head

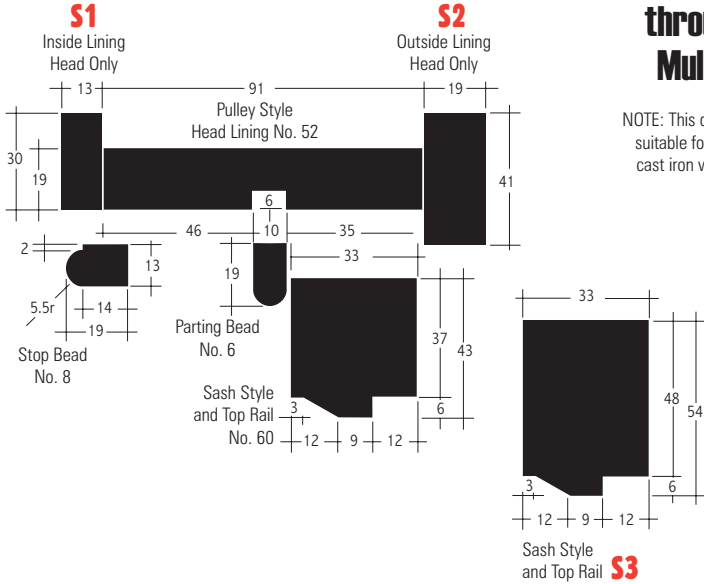

## Section through Mullion

NOTE: This detail is suitable for round cast iron weights

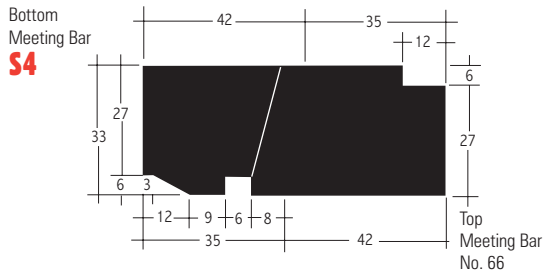
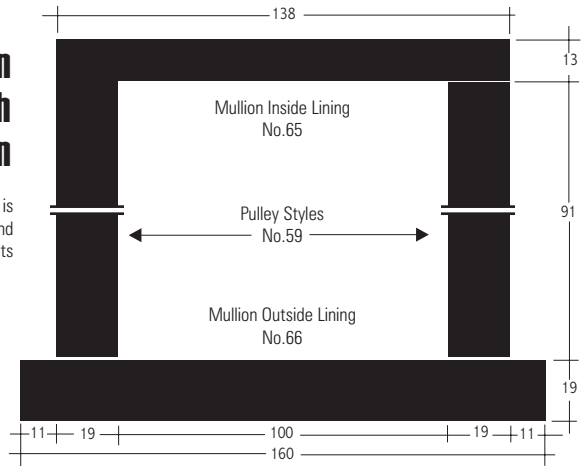

## Section through Mullion

NOTE: This detail is suitable for lead weights

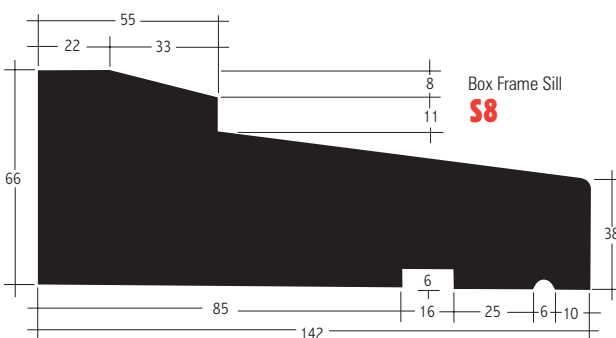
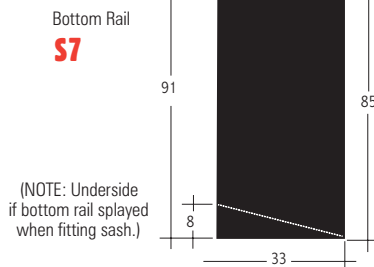
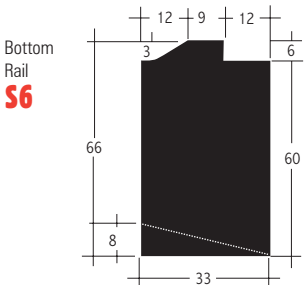
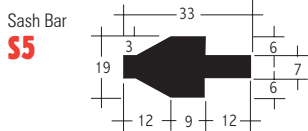
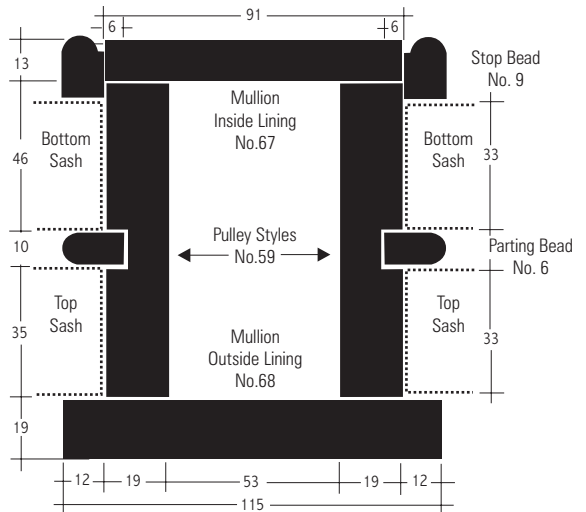

## Section through Left Hand Box

NOTE: Back lining for brick buildings only

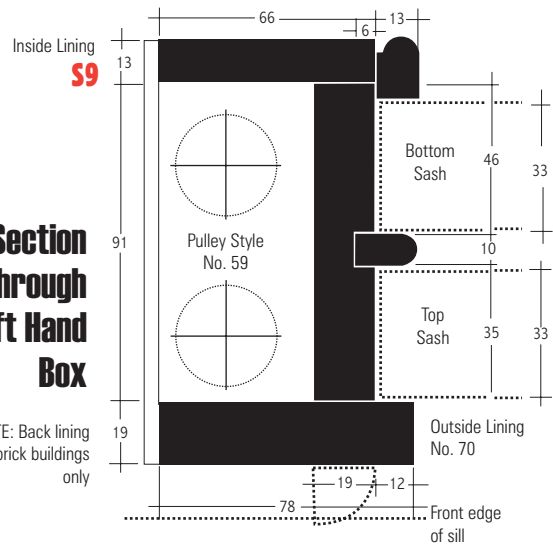

# DETAIL OF BOX FRAME MATERIAL AND 44mm SASH STOCK

## Vertical Section through Sill Sashes and Head

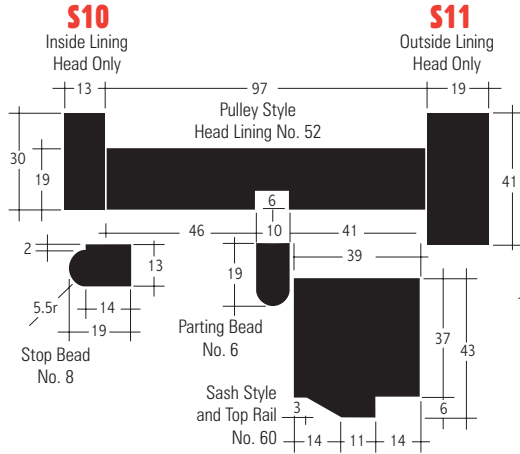

## Section through Mullion

NOTE: This detail is suitable for round cast iron weights

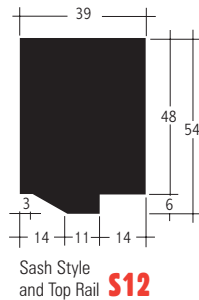
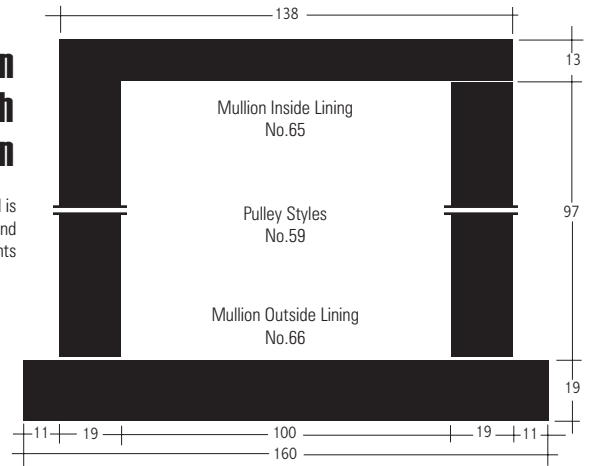

## Section through Mullion

NOTE: This detail is suitable for lead weights

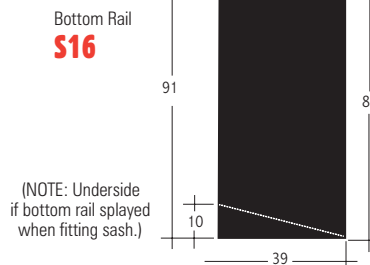
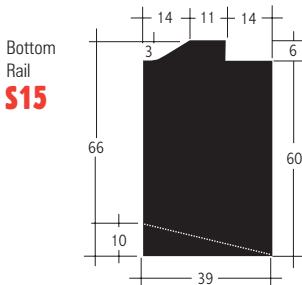
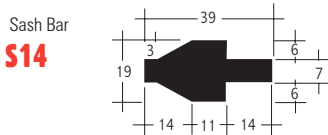
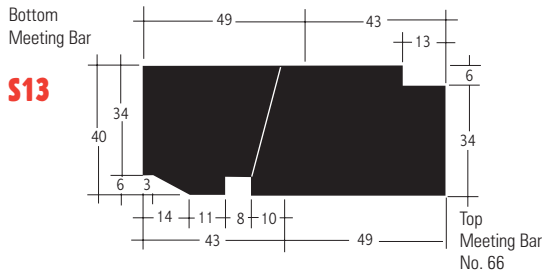
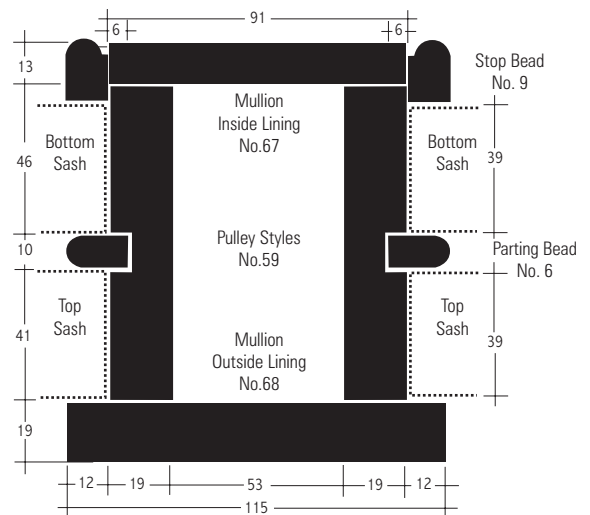

## Section through Left Hand Box

NOTE: Back lining for brick buildings only

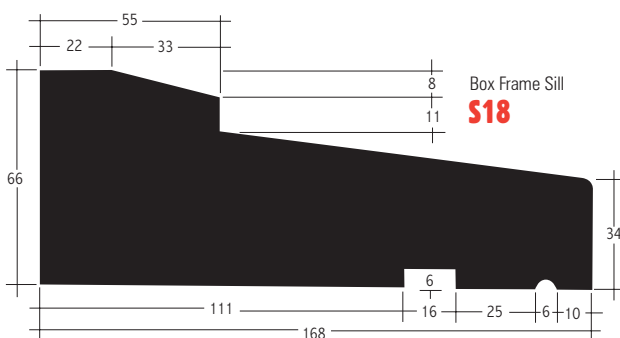
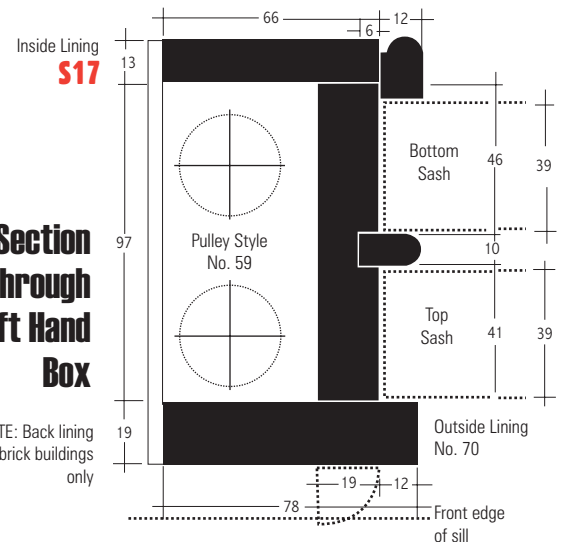

**Mullion WF1**

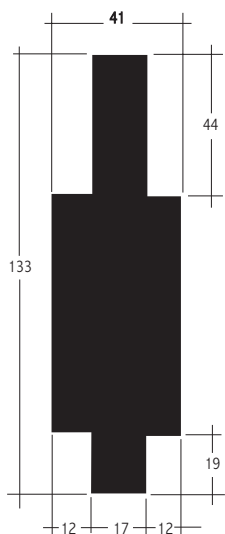

**Chair Rail WF2**

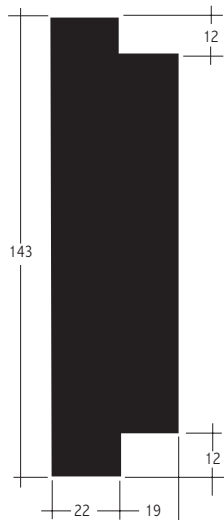

**Chair Rail WF3**

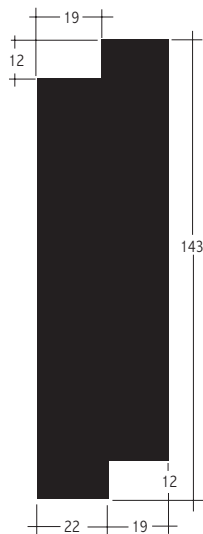

**Style WF4**

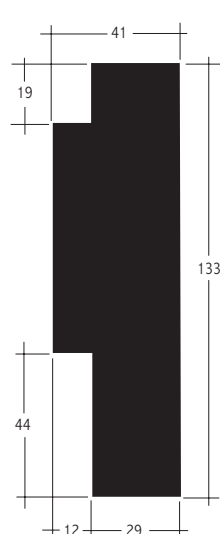

**Sill WF5**

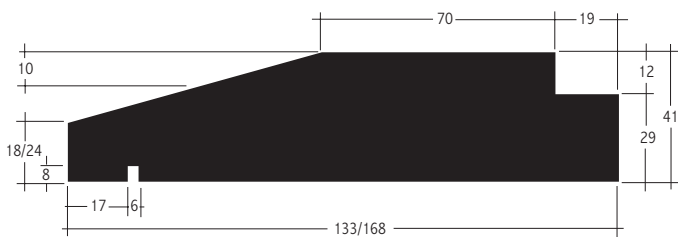

**Transom WF6**

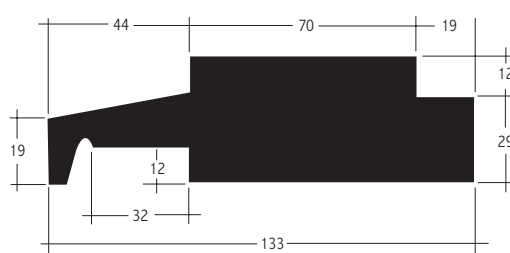

**Sash WF7**

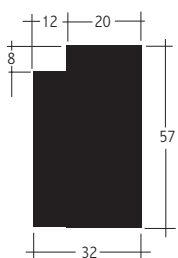

**Colonial GLZ Bar WF8**

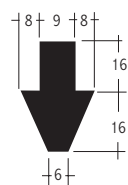

**Wind Mould WF9**

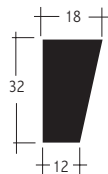

**Head WF10**

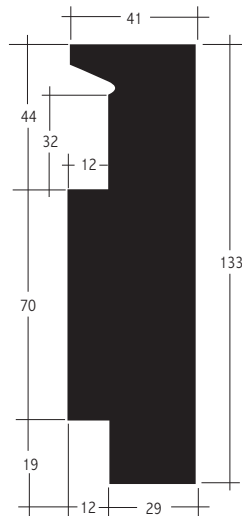

**Glazing Bead WF11**



**Sash Bead WF12**

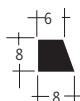

	Exposure	Typical use/Hazard	Availability
<b>H1</b>	Inside, above ground, dry	Insect borer (other than termites) hazard Framing, flooring, furniture, etc	Generally to order
<b>H2</b>	Inside, above ground, dry	Insect borer and termite hazard Framing, flooring, trusses	Stocks available: framing 70 x 35 90 x 35 70 x 45 90 x 45 other sizes to order
<b>H3</b>	Outside, above ground	Moderate fungal decay and termite hazard Decking, fencing, cladding, fascia, window joinery, exterior structural timber	Available ex-stock
<b>H4</b>	Outside, in ground	High fungal decay and termite hazard Fencing, greenhouses, pergolas, non-structural and landscaping timbers	Available ex-stock
<b>H5</b>	Outside, in ground or fresh water	High fungal decay and termite hazard Engineered retaining walls, building poles, pilings and cooling tower fill, structural or critical applications	Generally to order
<b>H6</b>	Marine water exposure	Marine borers hazard Marine piles, jetty crossbracing, landing steps, sea walls	Generally to order

Using treated timber in a higher hazard level than it is intended for may result in premature failure. Note that the hazard level of treatment is not related to the stress grade or other engineering properties of the timber.

**Handrail T1** 79 x 63

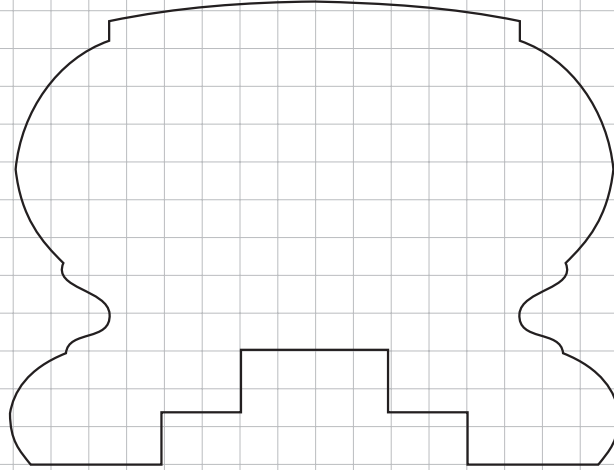

**Handrail T2** 88 x 42

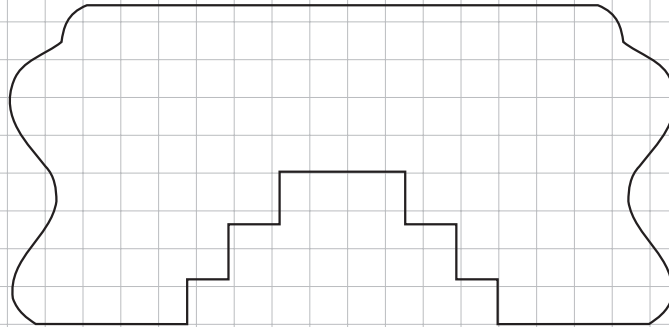

**Colonial AS2** 66 x 18



Supplied by



Published by the Timber and Building Materials Association (NSW) Limited  
ABN 12 000 045 956. 13–29 Nichols Street, Surry Hills, NSW 2010 Australia  
PO Box 107, Surry Hills NSW 2010 Australia  
Telephone (02) 9360 3088. Fax (02) 9360 3464

© Copyright



Australian Government  
Forest and Wood Products  
Research and Development  
Corporation

